

APPROXIMATED CALCULATION OF THE KIRCHHOFF PLATE RESTING ON THE VLASOV FOUNDATION WITH SELECTED BOUNDARY CONDITIONS

Konstantin Rusakov, Mykola Nagirniak✉

Institute of Civil Engineering, Warsaw University of Life Sciences – SGGW, Warsaw, Poland

ABSTRACT

The paper presents the problem of bending of the Kirchhoff plate resting freely on the elastic Vlasov subsoil with additional external load g to the subsoil applied near the transverse edge of the plate. The presented example is a special case of a plate resting freely on an elastic subsoil, it is common in construction industry. It was considered approximately, how an additional soil load g applied along the y -axis affects the deflection of a plate resting freely on the Vlasov foundation. Deflection diagrams of the plate and the surface of the elastic foundation outside the plate boundaries have been obtained. The diagrams of deflection of the plate middle surface and the displacements of the soil surface beyond the plate boundaries (in the transverse and longitudinal directions, taking into account the additional load g beyond the plate boundary) depending on the distance in the x -axis direction of this load were calculated.

Key words: Kirchhoff plate, Vlasov foundation, work of forces, plate deflection

INTRODUCTION

In the structural mechanics, the theory of plates is one of the most important issues keeping researchers interested in this topic.

The analysis of the literature on the theory of plates can be concluded that the theory of homogeneous thin plates can be used when the quotient of the plate thickness h and its width a is lower than $1/10$ (Jemielita, 2001). In the case of homogeneous plates with $h/a > 1/10$ and investigations of the boundary effect (Bolle, 1947) or stress concentration, the theories of middle thickness plates must be used (for example the Hencky–Bolle model). In the case of plates resting on a subsoil, existing calculation methods are not yet perfect and in general do not allow for the calculation of complex spatial systems. One of the most effective

ways of solving such complex problems are approximate methods. In addition, the hypotheses assumed with regard to the behavior of a ground soil (Vlasov & Leontiev, 1960) cannot be recognized as perfect either.

The issues of interaction of the structure and the ground most often concern the foundations and lining of excavations. It is known that the foundations of high buildings are calculated by the finite element method with use of an elastic-plastic soil model. For smaller objects, programs with the Winkler foundation model are used but this model does not take into account the variability of the soil elasticity and the displacement of the soil outside the place of load. Due to this fact, it is reasonable for simple calculations to use the Vlasov elastic foundation for thin Kirchhoff plates (Ozgan, 2013; Höller et al., 2019; Yue, Wang,

Konstantin Rusakov <https://orcid.org/0000-0002-6683-0547>; Mykola Nagirniak <https://orcid.org/0000-0003-4996-7397>

✉ mykola_nagirniak@sggw.edu.pl

Jia, Wu & Wang, 2020), what allows to calculate the cross-sectional forces and to change the parameters of the plate and the subsoil in a wide range.

TWO-PARAMETER MODEL OF THE ELASTIC VLASOV SOIL

Two-dimensional models of elastic foundation are divided into two groups:

- 1) models resulting from the equations of the theory of elasticity after introducing certain simplifications – they are called structural models,
- 2) models created by means of combination of layers with different material characteristics – these are the so-called multiparameter phenomenological models (Jemielita, 1992, 1994).

The Vlasov elastic foundation model is a structural model. Denoting by $q(x, y)$ and $w_s(x, y, z)$ the load acting on the ground and the vertical displacement, respectively, one can write the equation of the two-parameter Vlasov foundation as (Vlasov & Leontiev, 1960):

$$q(x, y) = k w_s(x, y) - 2t \nabla^2 w_s(x, y) \quad (1)$$

where:

k – stiffness coefficient of the foundation, which characterizes the compressive work of the foundation [$\text{N} \cdot \text{m}^{-3}$],

t – stiffness coefficient of the foundation, which characterizes the foundation shear work [$\text{N} \cdot \text{m}^{-1}$].

The elastic constants k and t can be determined from the formulas (Vlasov & Leontiev, 1960):

$$k = \frac{E_0}{1 - \nu_0^2} \int_0^H \left(\frac{d \vartheta(z)}{dz} \right)^2 dz$$

$$t = \frac{E_0}{4(1 + \nu_0)} \int_0^H \vartheta^2(z) dz$$

where:

$$E_0 = \frac{E_s}{1 - \nu_s^2},$$

$$\nu_0 = \frac{\nu_s}{1 - \nu_s},$$

H – foundation thickness [m],

ν_s – Poisson ratio of the soil [–],

E_s – Young modulus of the soil [$\text{N} \cdot \text{m}^{-2}$].

The function $\vartheta(z)$ is the function of displacement distribution in the ground, it is assumed $\vartheta(0) = 1$, $\vartheta(H) = 0$. In the monograph of Vlasov and Leontiev (1960), the following functions $\vartheta(z)$ of the disappearance of displacements along depth were proposed:

$$\vartheta(z) = 1 - \frac{z}{H}, \quad \vartheta(z) = \frac{\text{sh}[\gamma(H-z)]}{\text{sh}[\gamma H]}, \quad \vartheta(z) = e^{-\gamma z} \quad (2)$$

where γ is the rate of displacement distribution along depth [$\text{N} \cdot \text{m}^{-1}$].

DIFFERENTIAL EQUATION OF KIRCHHOFF PLATE RESTING ON VLASOV FOUNDATION

Assume that the contact between the plate and the soil always exists. It means that it is satisfied an equality $w(x, y) = w_s(x, y, 0)$. Under this assumption, there is always an interaction between the plate and the foundation. The load acting on the plate (related to the midplane) $p_3(x, y)$ is equal to

$$p_3(x, y) = p(x, y) - q(x, y)$$

where:

$w(x, y)$ – plate midplane deflection [m],

$p(x, y)$ – external load [$\text{N} \cdot \text{m}^{-2}$].

The differential equations of deflection of a plate resting on the Vlasov foundation (1) in the Cartesian coordinate system may be written as (Vlasov & Leontiev, 1960):

$$\nabla^4 w(x, y) - 2r_1^2 \nabla^2 w(x, y) + s_1^4 w(x, y) = \frac{p(x, y)}{D} \quad (3)$$

where:

$$r_1^2 = \frac{t}{D},$$

$$s_1^4 = \frac{k}{D},$$

$D = \frac{E_p h^3}{12(1 - \nu^2)}$ – elastic modulus by bending of the plate [$\text{N} \cdot \text{m}$],

E_p – Young modulus of the plate [$\text{N} \cdot \text{m}^{-2}$],

ν – Poisson ratio of the plate [–],

h – thickness of the plate [m].

APPROXIMATED SOLUTION OF THE PLATE FREELY RESTING ON VLASOV SUBSOIL WITH ADDITIONAL LOAD NEAR ONE EDGE

Consider a rectangular plate, symmetrically loaded, resting freely on a single-layer elastic subsoil as shown in Figure 1. Additionally, the load g is applied to the subsoil at a distance a_1 from the transverse edge of the plate. It has been investigated the plate deflection under an influence of the vertical load (rigid beam) applied at the distance a_1 along the y -axis.

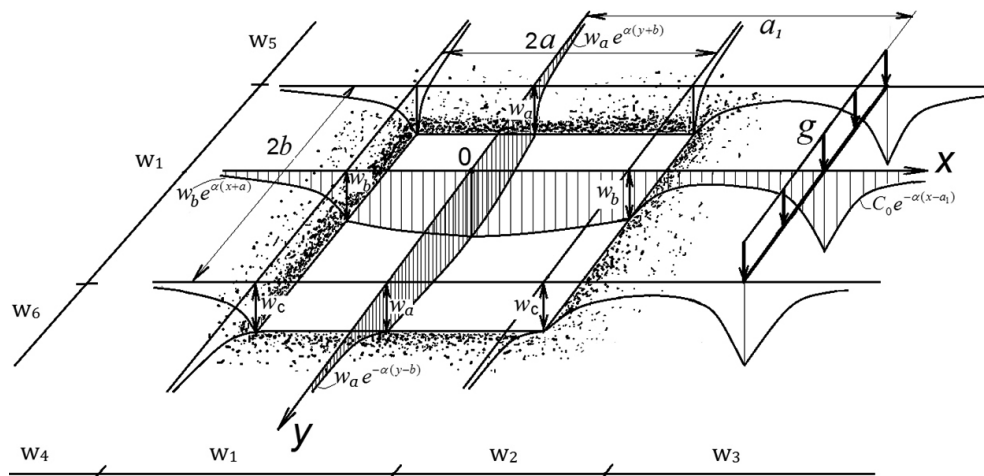

Fig. 1. Plate freely resting on an elastic foundation with additional load g near one edge

The problem under consideration is solved on the basis of the principle of superposition and can be divided into two stages: the first one – deflection of the plate resting freely on the elastic foundation, and the second one – deflection of an elastic foundation loaded uniformly along the y -axis by a rigid beam.

First stage. Deflection of the plate resting freely on the elastic foundation (Fig. 2)

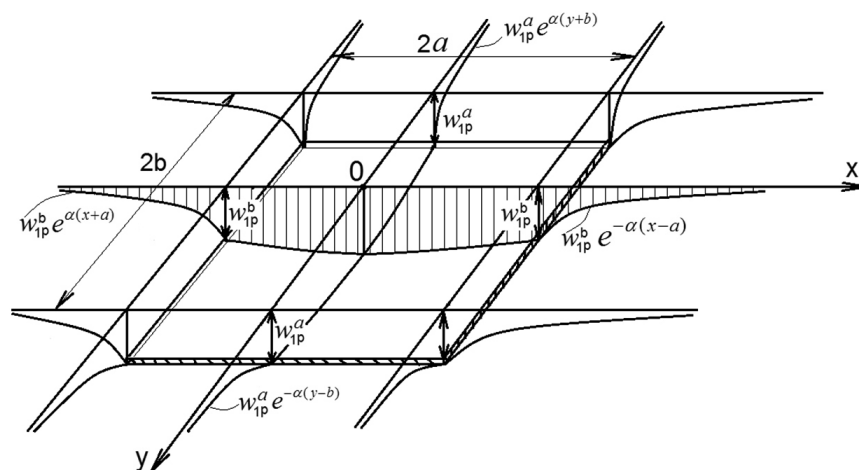

Fig. 2. Plate freely resting on an elastic foundation

The plate displacements $w_{1p}(x, y)$ are presented as (Vlasov & Leontiev, 1960):

$$w_{1p}(x, y) = C_1 + C_2 \cos\left(\frac{\pi x}{2a}\right) + C_3 \cos\left(\frac{\pi y}{2b}\right) + C_4 \cos\left(\frac{\pi x}{2a}\right) \cos\left(\frac{\pi y}{2b}\right) \quad (4)$$

where C_1, C_2, C_3 and C_4 are constant coefficients measured in units of length.

The assumption of displacements $w_{1p}(x, y)$ given by Eq. (4) meets the geometrical conditions of the problem under consideration. The first component is defined as settling of the plate as a rigid element, the second and third components are the cylindrical bending of the plate in the x and the y directions, respectively, and the last component characterizes the plate bending in both directions.

To determine the coefficients C_i we use the condition that the total work of internal and external plate forces on possible unit displacements is equal to zero:

$$\begin{aligned} \bar{w}_1 &= 1, \bar{w}_2 = \cos\left(\frac{\pi x}{2a}\right), \bar{w}_3 = \cos\left(\frac{\pi y}{2b}\right) \\ \bar{w}_4 &= \cos\left(\frac{\pi x}{2a}\right) \cos\left(\frac{\pi y}{2b}\right) \end{aligned} \quad (5)$$

where \bar{w}_i ($i = 1, 2, 3, 4$) is a virtual displacement of the plate.

Apart from these forces, it is necessary to take into account additional reactions Q^f along the edges of the plate, what requires to consider the work of the elastic foundation outside the plate boundaries (Fig. 3). In the case of rectangular Kirchhoff plates, corner forces R^f are generated at the corners of the plates. The reactions Q^f and R^f can be written as (Vlasov & Leontiev, 1960):

$$Q_b^f = 2t \left[\alpha w_{1p} + \frac{dw_{1p}}{dx} - \frac{1}{2\alpha} \frac{d^2 w_{1p}}{dy^2} \right]_b \quad (6)$$

$$Q_a^f = 2t \left[\alpha w_{1p} + \frac{dw_{1p}}{dy} - \frac{1}{2\alpha} \frac{d^2 w_{1p}}{dx^2} \right]_a \quad (7)$$

$$R^f = \frac{3}{2} t w_c$$

where w_c is a value of the deflection function at a plate corner points.

The index b in Eq. (6) means that the values of the deflection function $w_{1p}(x, y)$ and its derivatives should be calculated at the points on the longitudinal side of the plate ($x = \pm a$). The index a in Eq. (7) means that the values of the deflection function $w_{1p}(x, y)$ and its derivatives should be calculated at the points on the transverse side of the plate ($y = \pm b$).

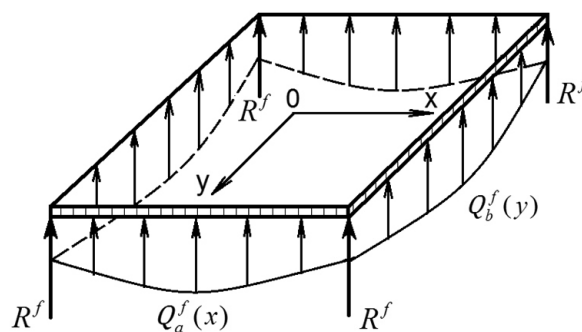

Fig. 3. Additional reactions Q^f and corner forces R^f of a plate freely resting on the elastic foundation

Writing down the expression for the work of all internal and external forces on possible displacements (5) for the Kirchhoff plate resting on elastic foundation, one obtains a system of four equations from which the coefficients C_1, C_2, C_3 and C_4 can be determined:

$$\begin{cases} \int_{-a}^a \int_{-b}^b \left(s_1^4 w_{1p} - \frac{p}{D} \right) dx dy + \frac{2}{D} \left(\int_{-a}^a Q_b^f dx + \int_{-b}^b Q_a^f dy + 4R^f \right) = 0 \\ \int_{-a}^a \int_{-b}^b \left(\frac{d^4 w_{1p}}{dx^4} - 2r_1^2 \frac{d^2 w_{1p}}{dx^2} + s_1^4 w_{1p} - \frac{p}{D} \right) \cos\left(\frac{\pi x}{2a}\right) dx dy + \frac{2}{D} \int_{-a}^a Q_a^f \cos\left(\frac{\pi x}{2a}\right) dx = 0 \\ \int_{-a}^a \int_{-b}^b \left(\frac{d^4 w_{1p}}{dy^4} - 2r_1^2 \frac{d^2 w_{1p}}{dy^2} + s_1^4 w_{1p} - \frac{p}{D} \right) \cos\left(\frac{\pi y}{2b}\right) dx dy + \frac{2}{D} \int_{-b}^b Q_b^f \cos\left(\frac{\pi y}{2b}\right) dy = 0 \\ \int_{-a}^a \int_{-b}^b \left(\nabla^4 w_{1p} - 2r_1^2 \nabla^2 w_{1p} + s_1^4 w_{1p} - \frac{p}{D} \right) \cos\left(\frac{\pi x}{2a}\right) \cos\left(\frac{\pi y}{2b}\right) dx dy = 0 \end{cases}$$

The displacements of the soil surface outside the plate boundaries will be assumed in the form:

$$\begin{aligned} \text{for } x < -a, \quad w_{1p}^b e^{\alpha(x+a)} \\ \text{for } x > a, \quad w_{1p}^b e^{-\alpha(x-a)} \\ \text{for } y < -b, \quad w_{1p}^a e^{\alpha(y+b)} \\ \text{for } y > b, \quad w_{1p}^a e^{-\alpha(y-b)} \end{aligned} \quad (8)$$

Note that w_{1p}^b in Eq. (8) denotes the value of the deflection function $w_{1p}(x, y)$ at the points on the longitudinal side of the plate ($x = \pm a$), while w_{1p}^a denotes the deflection function $w_{1p}(x, y)$ at the points on the transverse side of the plate ($y = \pm b$).

Second stage. Deflection of an elastic foundation loaded uniformly along the y-axis by a rigid beam (Fig. 4)

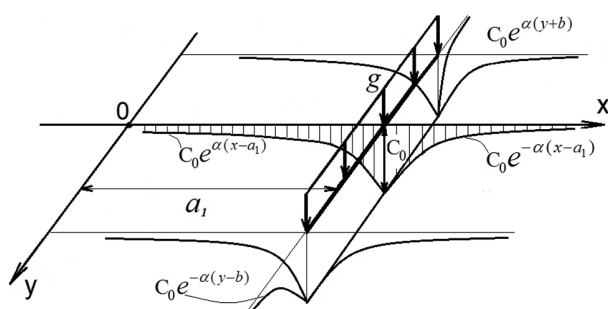

Fig. 4. The elastic foundation loaded uniformly along the y-axis by a rigid beam

Assuming that the settlement under this load is constant over the entire length on which it is applied, the displacement $v(x, y)$ may be written as:

$$v(a_1, y) = C_0 \quad (9)$$

The coefficient C_0 from Eq. (9) is determined from the condition that the projections of all forces on the z-axis acting on the rigid beam are equal to zero:

$$C_0 = \frac{2 b g}{2(k b + 2 \alpha t)}$$

where:

b – half length of the plate [m],

g – load magnitude applied to the rigid beam [$\text{N} \cdot \text{m}^{-1}$],

$$k = \frac{E_0}{1-\nu_0^2} \int_0^H \left(\frac{d \vartheta(z)}{dz} \right)^2 dz,$$

$$t = \frac{E_0}{4(1+\nu_0)} \int_0^H \vartheta^2(z) dz,$$

$$\alpha = \sqrt{\frac{k}{2t}}.$$

A final solution to the problem presented in Figure 1 is the sum of the first and the second solution.

Ultimately, the displacement of the soil surface over the entire area under consideration is written as:

$$\begin{cases} w_1 = w_{1p} + C_0 e^{\alpha(x-a_1)} \\ w_2 = w_{1p}^b e^{-\alpha(x-a)} + C_0 e^{\alpha(x-a_1)} \\ w_3 = w_{1p}^b e^{-\alpha(x-a)} + C_0 e^{-\alpha(x-a_1)} \\ w_4 = w_{1p}^b e^{\alpha(x+a)} \\ w_5 = w_{1p}^a e^{\alpha(y+b)} \\ w_6 = w_{1p}^a e^{-\alpha(y-b)} \end{cases} \quad (10)$$

CALCULATION EXAMPLE

As an example, consider the plate shown in Figure 1. Assume the following geometrical dimensions and stiffness characteristics of the plate and the soil:

$$a = 7 \text{ m}, b = 1.5a, H = 2a, h = 0.5 \text{ m}$$

$$\nu_s = 0.25, \nu = 0.3, E_s = 50 \cdot 10^3 \text{ kN} \cdot \text{m}^{-2}, E_p = 27 \cdot 10^6 \text{ kN} \cdot \text{m}^{-2}$$

The function of displacement distribution along depth is assumed in a form:

$$\vartheta(z) = 1 - \frac{z}{H} \quad (11)$$

For the linear displacement distribution function along depth (11), the displacements (10) are as follows:

$$\begin{aligned}
 w_1 &= 0.0004g e^{0.214(x-a_1)} + p \left[0.00007 + (0.00004 + 0.00001 \cos(0.15y)) \cos\left(\frac{\pi x}{14}\right) + 0.00006 \cos(0.15y) \right] \\
 w_2 &= 0.0004g e^{0.214(x-a_1)} + p e^{-0.214x} [0.0003 + 0.00027 \cos(0.15y)] \\
 w_3 &= e^{-0.214x} [0.0004 g e^{0.214 a_1} + 0.0003 p + 0.00027 p \cos(0.15y)] \\
 w_4 &= e^{0.214x} [0.0004 g e^{-0.214 a_1} + 0.0003 p + 0.00027 p \cos(0.15y)] \\
 w_5 &= 9.487 e^{0.214y} \left[0.0004 g e^{-0.214(x-a_1)} + 0.00007 p + 0.00004 p \cos\left(\frac{\pi x}{14}\right) \right] \\
 w_6 &= 9.487 e^{-0.214y} \left[0.0004 g e^{-0.214(x-a_1)} + 0.00007 p + 0.00004 p \cos\left(\frac{\pi x}{14}\right) \right]
 \end{aligned}$$

The diagrams of the deflection of the middle surface of the plate and the displacement of the soil surface outside the plate boundaries are presented in Figures 5–10.

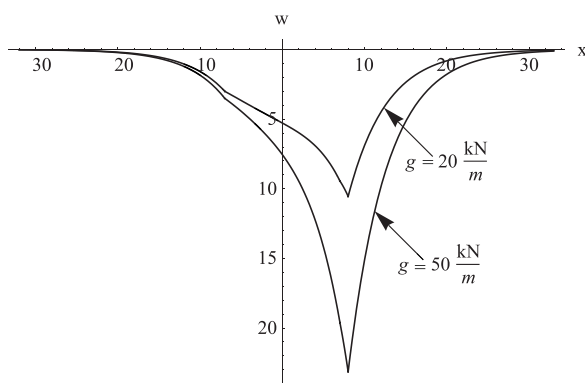

Fig. 5. Deflection $w(x, 0)$ of Kirchhoff plate on the Vlasov elastic foundation for $a_1 = a + 1$

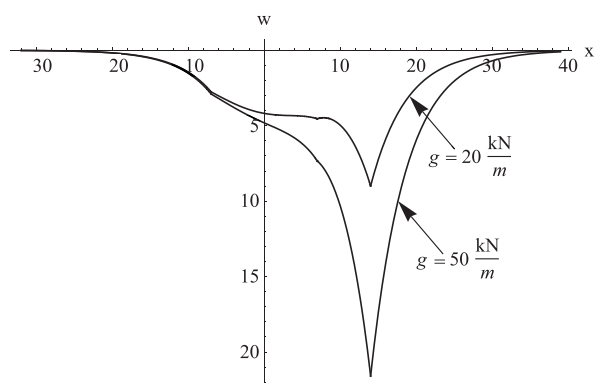

Fig. 6. Deflection $w(x, 0)$ of Kirchhoff plate on the Vlasov elastic foundation for $a_1 = 2a$

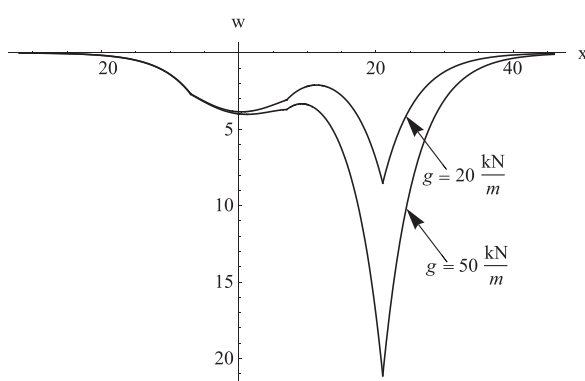

Fig. 7. Deflection $w(x, 0)$ of Kirchhoff plate on the Vlasov elastic foundation for $a_1 = 3a$

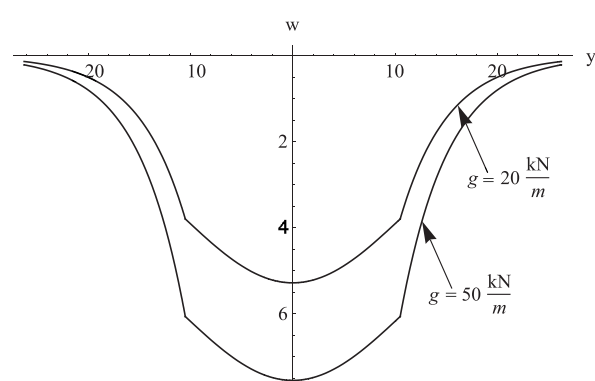

Fig. 8. Deflection $w(0, y)$ of Kirchhoff plate on the Vlasov elastic foundation for $a_1 = a + 1$

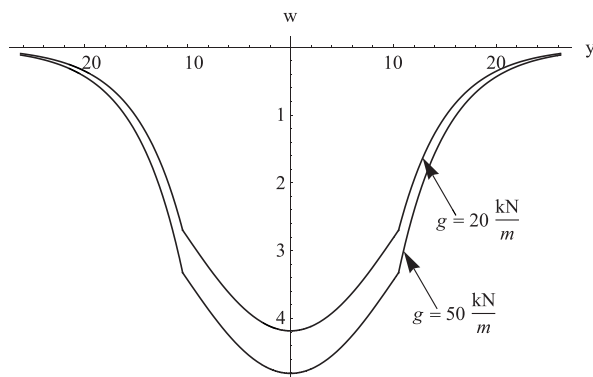

Fig. 9. Deflection $w(0, y)$ of Kirchhoff plate on the Vlasov elastic foundation for $a_1 = 2a$

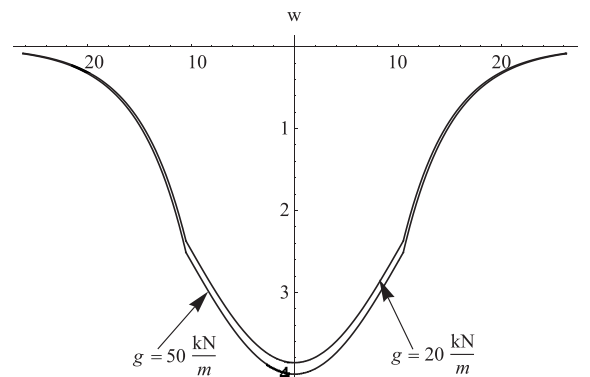

Fig. 10. Deflection $w(0, y)$ of Kirchhoff plate on the Vlasov elastic foundation for $a_1 = 3a$

Figures 5–7 show the diagrams of the plate deflection and surface displacements of the elastic foundation located outside the plate boundaries for $y = 0$ at various distances a_1 of the additional load (rigid beam) from the longitudinal edge of the plate. In the case where the load is applied in the immediate vicinity of the longitudinal edge of the plate $a_1 = (a + 1 \text{ m})$, strong influence of the load g on the plate deflection is observed. Increasing the distance a_1 for the same load values) the deflection of the plate decreases and the character of the deflection curve changes. Figures 5–7 show that if the distance increases, there is an increasingly pronounced cylindrical bending of the plate in the transverse direction. For sufficiently large values of a_1 , the effect of the g on the deformed state of the plate tends to zero and the considered case of symmetric loading of the plate causes its cylindrical bending.

Figures 8–10 show the deflections of the plate and the elastic foundation beyond its boundaries in the direction of the y -axis at $x = 0$.

It should be noted that the considered method is applicable only for determining displacements. Static equilibrium conditions of the plate are met approximately. In sections $x = \pm a$, the bending moment M_x should be zero, but this condition is not satisfied in the considered superposition method.

CONCLUSIONS

The paper presents results of an approximated calculation for Kirchhoff plate resting freely on the Vlasov elastic foundation with additional load g near plate edge. Plate deflection function $w(x, y)$ was expressed in such a way that it satisfies the geometrical boundary conditions, namely, the deflection function is different from zero on the plate edge. The static boundary conditions have been met as approximated. The calculations of simple approximated displacement function of the soil surface beyond the plate boundaries were performed by CAS Mathematica. The selection of the plate deflection function in the form of Eq. (4) is not only one possible. The displacement of the foundation surface beyond the plate boundaries was assumed as approximation – the settlement of the elastic foundation in spatial conditions outside the plate boundaries will be more complex.

The system of algebraic equations allowing to determine the constants C_i was obtained by equating to zero the work of all the forces in the plate movements and the possible continuity conditions. The displacement distribution function $\mathcal{G}(z)$ along depth was linear. The constants C_i were determined for the assumed parameters of the plate and soil. Diagrams of the plate deflection and the displacements of soil surface for g equals to 20 and 50 $\text{kN}\cdot\text{m}^{-1}$ were presented. In case when the additional load $g \rightarrow 0$ or $a_1 \rightarrow \infty$, the deflection character in the transverse direction is the same as in the longitudinal direction.

REFERENCES

- Bolle, L. (1947). Contribution au problème linéaire de flexion d'une plaque élastique. *Bulletin Technique de la Suisse Romande*, 73, 293–298.
- Höller, R., Aminbaghai, M., Eberhardsteiner, L., Eberhardsteiner, J., Blab, R., Pichler, B. & Hellmich, C. (2019). Rigorous amendment of Vlasov's theory for thin elastic plates on elastic Winkler foundations, based on the Principle of Virtual Power. *European Journal of Mechanics / A Solids*, 73, 449–482.
- Jemielita, G. (1992). Generalization of the Kerr foundation model. *Journal of Theoretical and Applied Mechanics*, 4 (30), 843–853.
- Jemielita, G. (1994). Governing equations and boundary conditions of a generalized model of elastic foundation. *Journal of Theoretical and Applied Mechanics*, 4 (32), 887–901.
- Jemielita, G. (2001). Teorie płyt sprężystych. In C. Woźniak (Ed.), *Mechanika techniczna*. Vol. 8. *Mechanika sprężystych płyt i powłok*. Warszawa: Wydawnictwo Naukowe PWN.
- Ozgan, K. (2013). Dynamic analysis of thick plates including deep beams on elastic foundations using modified Vlasov model. *Shock and Vibration*, 20 (1), 29–41.
- Vlasov, V. & Leontiev, N. (1960). *Balki, plity i oboločki na uprugom osnovanii*. Moskva: Gosudarstvennoe izdatel'stvo fiziko-matematičeskoj literatury.
- Yue, F., Wang, F., Jia, S., Wu, Z. & Wang, Z. (2020). Bending analysis of circular thin plates resting on elastic foundations using two modified Vlasov models. *Mathematical Problems in Engineering*, 2020, 2345347. <https://doi.org/10.1155/2020/2345347>

PRZYBLIŻONE OBLICZENIE PŁYTY KIRCHHOFFA SPOCZYWAJĄCEJ NA PODŁOŻU SPRĘŻYSTYM WŁASOWA O WYBRANYCH WARUNKACH BRZEGOWYCH

STRESZCZENIE

W pracy przedstawiono zagadnienie zginania płyty Kirchhoffa swobodnie spoczywającej na sprężystym podłożu Własowa z dodatkowym obciążeniem zewnętrznym podłoża g , przyłożonym w pobliżu krawędzi poprzecznej płyty. Podany przykład jest szczególnym przypadkiem płyty swobodnie spoczywającej na sprężystym podłożu, występującym w praktyce budowlanej. Rozpatrzono w przybliżeniu, jak przyłożone wzdłuż osi y dodatkowe obciążenie gruntu g wpływa na ugięcie płyty swobodnie spoczywającej na podłożu Własowa. Przedstawiono wykresy ugięcia powierzchni środkowej płyty i warstwy powierzchniowej gruntu poza granicami płyty (w kierunku poprzecznym i wzdłużnym z uwzględnieniem dodatkowego obciążenia g poza granicą płyty) w zależności od odległości w kierunku osi x tego obciążenia.

Słowa kluczowe: płyta Kirchhoffa, podłoże Własowa, praca sił, ugięcie płyty