

AN OVERVIEW OF BRIDGE PIER CONSTRUCTION SOLUTIONS, INCLUDING THE INDONESIAN APPROACH

Marta Kiraga¹ ✉, Ananto Yusuf Wicaksono²

¹Institute of Civil Engineering, Warsaw University of Life Sciences – SGGW

²Brawijaya University in Malang

ABSTRACT

The paper provides an overview of the shape of the bridge piers, including the Indonesian approach. Universal principles of piers construction are provided, however the construction solutions placed in tropical climate conditions are determined by regional factors, such as considerations of resistance to earthquakes, tsunamis or frequent floods. The exemplary shapes of the pillars in the plan and the ways of their foundation are presented as a result of the analysis of English, Polish and Indonesian language literature. The economic role of bridge is emphasized in the context of Indonesian archipelago, where it constitute a central component of transportation system. The damage to the bridge is becoming particularly severe for the economy of the Indonesian archipelago. Therefore other climate invoke different engineering problems. Structural solutions, which in a way respond to adverse climatic conditions are mainly using proper reinforcement in the case of piers, the drainage systems with a higher drainage capacity and metal components anti-corrosion treatment. Factors that should be considered in the design of the bridge pier shape, size, and configuration could be variously grouped and presented. From this study, following criteria can be distinguished: stability, location, seismic load, stream pressure, aesthetic, collision risk.

Key words: bridge structure, bridge piers, erosion, local scour, hydrotechnics

INTRODUCTION

During the water flow through the bridge section, the water is piled up in front of the hydrotechnical structure. The height of this damming up depends mainly on the geometry of the flume or channel, the flow rate, the type of traffic and above all on the shape of abutments and pillars. In the process of hydrotechnical structures design, equal importance should be placed on structural calculations related to the stability and strength of structures, as well as on the water and bed level analysis and correct hydraulic dimensioning of water structures or their elements. Improperly selected shapes of abutments and bridge pillars by constructors increase the risk of blockages and local water

table back-ups (Tyminiński 2010; Andrić & Lu, 2015; Markogiannaki & Tegos, 2018).

The bridge supports take the load from the supporting structure and transfer it together with other forces to the foundations on a sufficiently strong ground. A distinction is made between the extreme supports, i.e. abutments, and the intermediate supports, i.e. piers (Fig. 1). Bridges consist of two general components, superstructure, the portion above the bridge bearings traversing the obstacle, and substructure, the portion of the bridge below the bearing that supports the superstructure. As part of the substructure portion, the main function of piers is to sustain the vertical load and horizontal force from the superstructure (Taly, 1998; Lin & Yoda, 2017; Reis & Pedro, 2019).

Marta Kiraga <https://orcid.org/0000-0001-9729-4209>

✉marta_kiraga@sggw.pl

In the past, abutments and piers were made of wood, stone or strong brick, but nowadays they are made of concrete or reinforced concrete. The introduction of prefabricated elements is a factor accelerating the construction of bridges, however, the first attempts to use prefabricated elements seemed to be a factor hindering the development, being a burden on the economy, due to the necessity to carry out costly reconstruction and repair works. There are many reasons for this and not all of them have their origin in the idea of prefabrication itself. The essence of prefabricated technology is to create structures from many, often relatively small elements, resulting in the need to make a large number of joints, potentially weakest places, exposed to high dynamic loads. After the experience of the past period, with a great progress in the quality of available bridge construction and equipment materials and a clear improvement in the level of workmanship, a return to a wider use of prefabrication can be observed. Its advantages are used (ease of assembly and speed of construction), and its disadvantages are reduced or even eliminated (low durability) (Ahn, Chen & O'Connor, 2006; Krężel & Radziecki, 2007; Biliszczyk & Onysyk, 2016; Al-Rousan, 2020). In addition, bridge piers designers should also take into consideration providing aesthetics for the bridge structure (Reis & Pedro, 2019).

The cost of bridge piers is typically from 30 to 40% of the cost of building the entire bridge; in the case of deep water and unfavourable ground conditions it can even exceed 50%. Therefore, the bridge supports deserve a solid design effort to achieve the optimal concept and solution of the details of their foundations (Jaro-

miniak, 2011). The pier consists of the following parts (Fig. 2):

- the foundation, which transfers (directly or via piles) all loads to the ground;
- the load-bearing part (stem) of the pillar, which transfers the loads from the subsoil bed to the foundation;
- the streamlining part with the chamber, which transfers loads from the supporting part to the foundation, ensures gentle water flow in conditions conducive to the transport of large fractions of debris and pollution, breaks it apart;
- the pier is also equipped with a bench, which transfers loads from the ground plates to the supporting part;
- the bearing plates, which distribute the bearing pressures on the bearing bed;
- the cornice, which protects the supporting part against leaks, moreover is of architectural significance (Teli, Shrestha, Chapagain & Pathak, 2020).

The pillar situated in the river stream is subject to constant loads such as: the dead weight of the pillar, reactions from the dead weight of the spans and variable loads such as: vertical reactions from payloads on the spans, water displacement, braking forces from payloads, forces caused by bearing friction, factors related to weather conditions and therefore the geographical location of the building, for example, wind pressure acting parallel to the axis of the bridge on the elements above the bridge and on the pillar, wind pressure on the spans and the pillar acting perpendicularly to the axis of the bridge, ice sheet pressure on

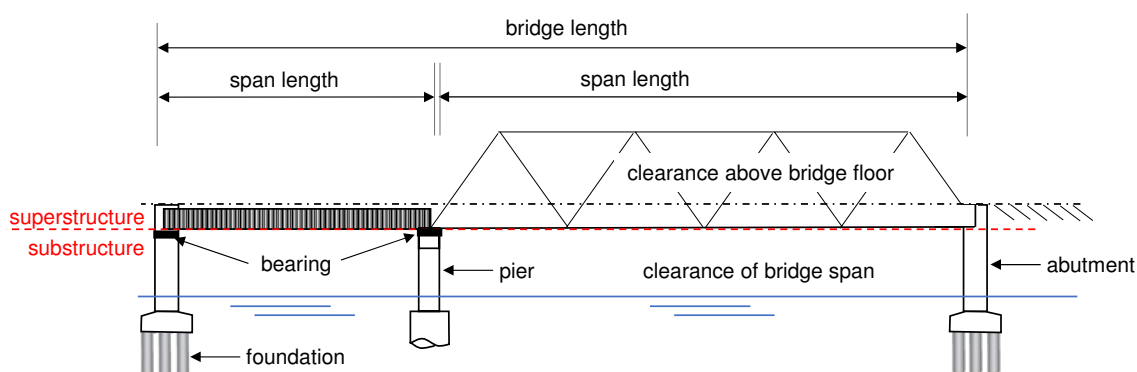

Fig. 1. Superstructure and substructure of bridges

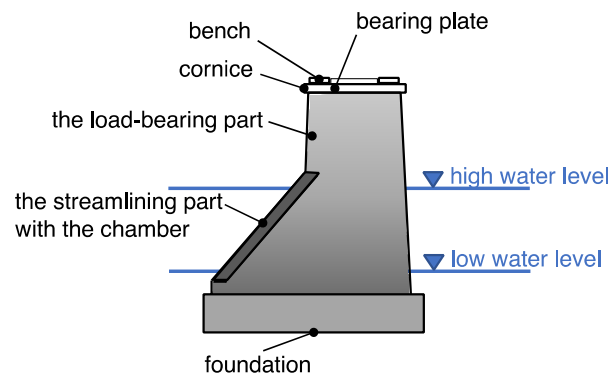

Fig. 2. Elements of bridge piers

the pillars, pressure acting on flood flows, increased waves etc. (Watts & Podolny, 1976; Wei et al., 2015; Jukowski & Bęc, 2016; Wang, Zhou, Jing, Zuo, Li & Li, 2019; Teli et al., 2020).

CONSTRUCTION SOLUTIONS FOR BRIDGE PIERS

The shape of the bridge pier is mainly influenced by the type of span structure, as well as by the orifice pressure, transport of large fractions of debris due to catastrophic flows, impact of river rolling stock, wind pressure, braking and side impact of the rolling stock on the bridge and the regulation force in cases of arch bridge pillars. The solutions for the formation of bridge pillars were indicated based not only on Polish or Indonesian literature, but also on the universality of solutions.

Regardless of the geographical location of a given bridge structure, the hydraulic calculations of the bridges include the determination of the minimum bridge light, the determination of the expected riverbed deepening in the bridge section, the piling height in front of the bridge and local scouring at the region of piers (Fig. 3). The process of local scouring is all the more intense the higher the velocity of the flowing water, which determines the ability of the stream to separate and carry soil particles. Local scouring in the region of the point obstacle that is the pier of the bridge can be continuously deepened. The increasing depth of the blur threatens the stability of the building elements, especially under conditions of intensive transformation of the riverbed during the passage of the overflow (Graf, 1998; Esmaeili, Dehghani, Zahiri,

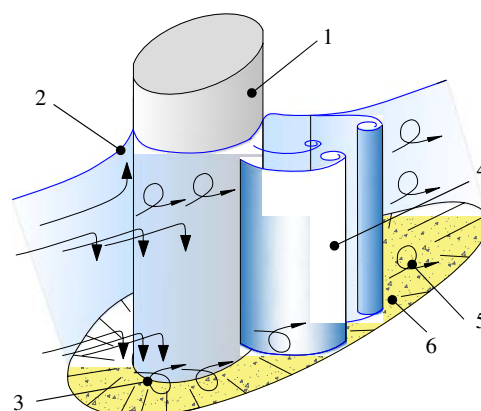

Fig. 3. Flow pattern and local scour around a cylindrical pier schematics: 1 – pier, 2 – bow wave, 3 – horseshoe vortice, 4 – lee-wake vortice, 5 – farwater vortice, 6 – local scouring area

& Suzuki, 2010; Jarominiak, 2016). It should be mentioned that about 70% of bridge failures were caused by local scouring in the region of pier, therefore on the basis of thorough analyses and, prior to the investment process, model tests, a differentiated shape of the bridge pillars is designed (Lewandowski, 1959; Dąbkowski, Skibiński & Żbikowski, 1982; Graf, 1998).

There are several ways to categorize the type of piers. Based on their sectional shape – solid or hollow, round, octagonal, and rectangular pier (Fig. 4). According to framing configuration, piers can be grouped into single or multiple column bent (2000 Regulation of Minister of Maritime Economy and Inland Navigation, Wang, 2000). Moreover, the edge of the pillar on the inlet side can take various shapes, from rectangular to lenticular (Fig. 5; 2000 Regulation of Minister of Maritime Economy and Inland Navigation; Vijayaraj, Eldho, Mazumder & Ahmad, 2017).

ground, as far as possible up to the solid ground, and it is only on these that the foundation is based. Therefore, the foundation of the bridge supports can be carried out as direct (flat) foundations or on a pile grid. Due to the intensity of dynamic loads and environmental factors, piling is considered to provide greater safety and durability than direct foundation (Fig. 6; Taly, 1998; 2000 Regulation of Minister of Maritime Economy and Inland Navigation; Chmielewski, 2015; Hassan, Karim & Al-Shukur, 2020).

Reis and Pedro (2019) grouped pier geometry into two categories: column piers, which could be solid or tubular piers; and wall piers, or alternatively called leaf piers (Figs. 7, 8). In the case of tubular piers enclosed space is often created for the users, either using large arcs of tubes or by plate girders forming a box-type of hollow conduit for passage (Matsagar et al., 2018).

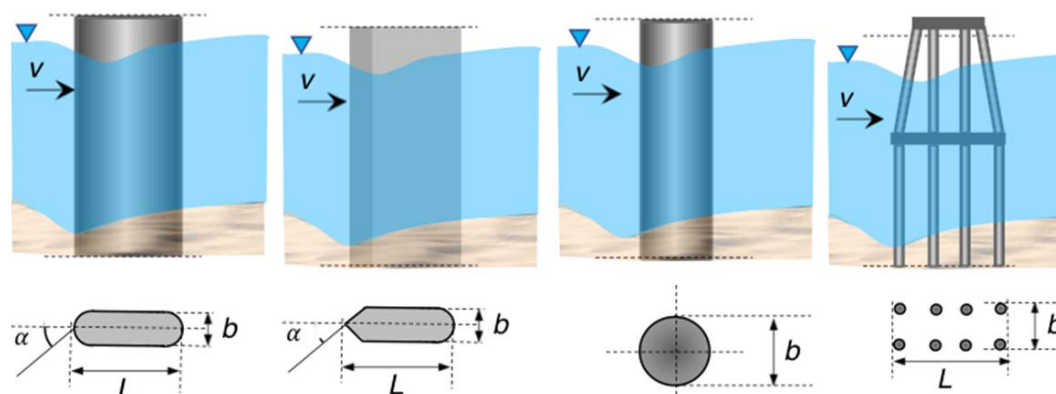

Fig. 4. A chosen pier construction types, where: v – stream velocity [$\text{m}\cdot\text{s}^{-1}$], α – the angle of deviation of the axis of the support from the direction of the water inflow [$^\circ$], L – the length of the pillar or set of pillars [m], b – the width of the pier [m]

The piers and abutments were laid on the foundations. It is very important that the foundation is strong enough and that water stream cannot wash it away. For this purpose, foundations are laid on a layer of solid ground in sufficient depth under the riverbed. The dimensions of the foundation must be adjusted to the quality of the soil. The weaker the soil, the more we have to extend the foundation so that the pressure on it is not too high. If the solid ground is at a considerable depth, piles, wooden or concrete are driven into the

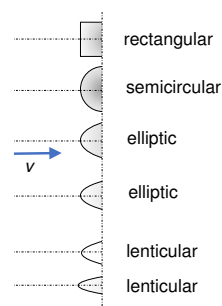

Fig. 5. Various construction of inflow part of bridge piers

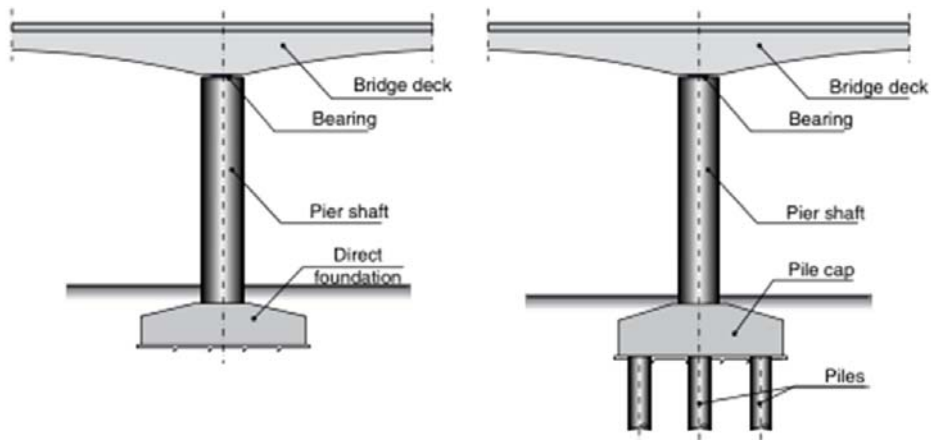

Fig. 6. A pier configuration on the foundation and pile cap

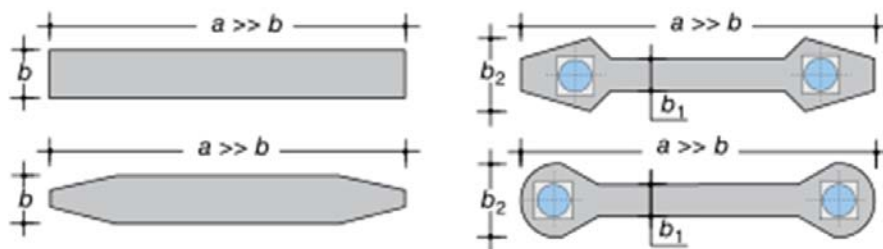

Fig. 7. Leaf (wall) piers used for a river crossing

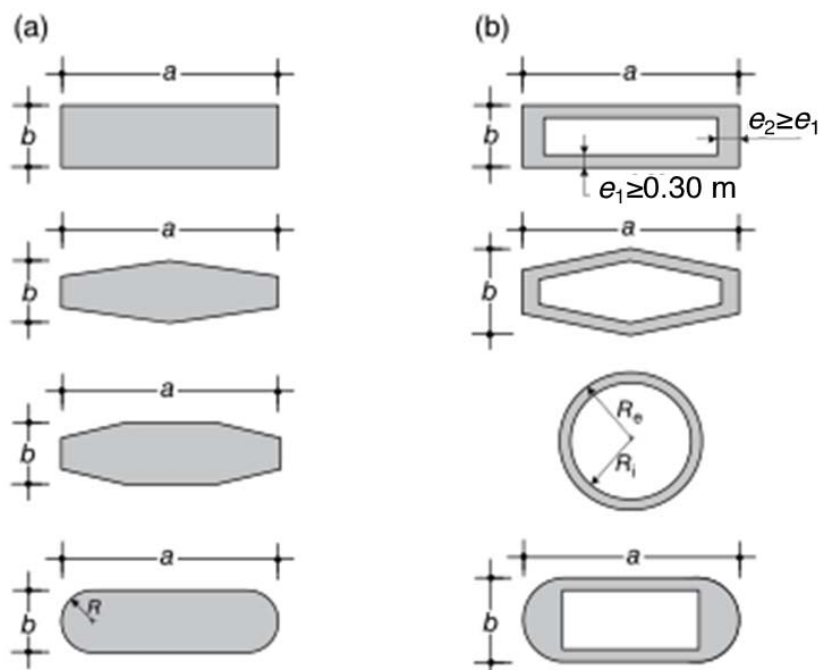

Fig. 8. Column piers used for an overcrossing: a – solid section, b – tubular piers

INDONESIAN APPROACH

Indonesia is the world's largest archipelago country that covers more than 17,000 islands and consists of 131 river basin territories with more than 5,700 rivers, containing many dams, weirs, and canals. In addition, the sea area of Indonesia constitutes about 81% of the total area of the country (Eitiveni & Sensuse, 2012; Asian Development Bank, 2016). Based on those conditions, the bridge started playing an important role in national development, as well as piers and support shapes, which play a significant role in the structure's safety.

In an almost entirely tropical climate in Indonesia, significant rainfall irregularities must be taken into account when designing hydrotechnical structures. In addition deforestation, drainage of wetlands, and conversion into agricultural land-use all over the country reduces the buffering capacity of the river catchments, resulting in higher peak flows in the wet season and lower base flows in the dry season, thereby increasing the risks of floods and droughts. Average annual rainfall in Indonesia is around 2,350 mm. Floods occurring almost every year in Jakarta are still a major unresolved problem. Beside hydrological reasons such as its geographical position in a flood plain of 13 rivers with high rainfall watersheds (more than 2,000 mm yearly rainfall) and backwater effects of high tides from the Jakarta bay. As a result of economic development population settlements and economic activities increase rapidly in Indonesia, especially along the floodplains of the rivers (Junaidi, Nurhamidah & Daoed, 2018).

Indonesia could be divided into three general climatic regions each with distinct characteristics. A region with monsoon-type rainfall is located in southern Indonesia from south Sumatera to Timor island, southern Kalimantan, Sulawesi, and part of Papua. A region with equatorial-type rainfall is located in northwest Indonesia from northern Sumatera to northwestern Kalimantan. A region with a local rainfall type encompasses Maluku and northern Sulawesi. Each of these regions have a different character of the course of rainy seasons during the year (Fig. 9; Asian Development Bank, 2016). The amount of rainfall depends largely on the winds that affect the islands. Between November and March it is the northern monsoon, while between May and September it is the southern monsoon.

The climate in Indonesia is characterized by high rainfall, frequent intense storms and large runoffs. Floods are a natural phenomenon. However, their effects are gradually increasing due to settlement and economic development in flood-prone areas. Floods have become a serious problem in Indonesia, particularly in Java, where a large and constantly growing population, combined with previous negligence in land-use planning and land management, has allowed for significant development in flood-prone areas, increasing the risk and damage caused by flooding. The following flood types can be distinguished: flash and river flooding, coastal flooding and urban flooding (Fig. 10). Widespread heavy rainstorms result in occasional flooding in polder areas in large cities (Pawitan & Haryani, 2011; Asian Development Bank, 2016).

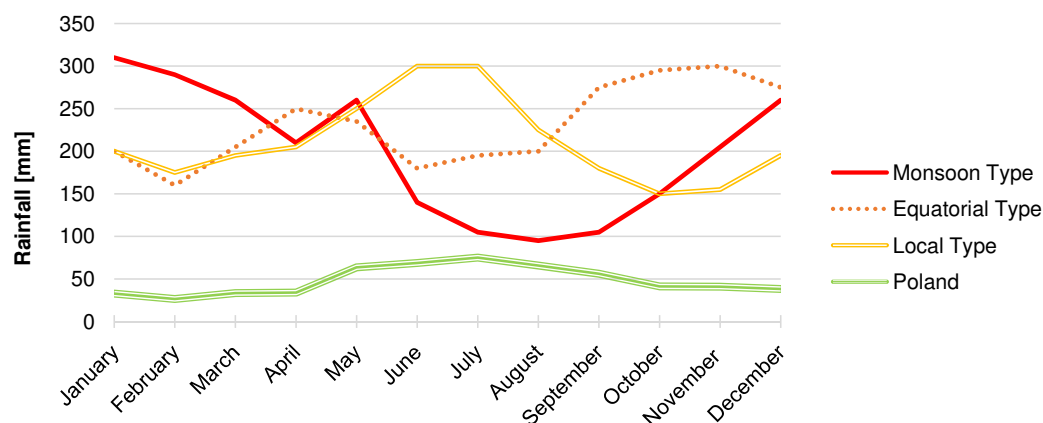

Fig. 9. Annual rainfall pattern in three regions of Indonesia and in Poland (Białystok)

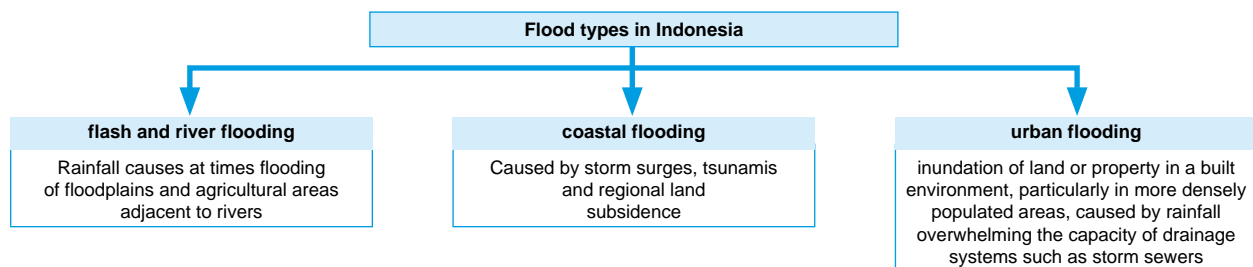

Fig. 10. Flood types in Indonesia

In many of Indonesia's upper catchment areas, mainly in densely populated areas of Java, natural woodland vegetation is removed to facilitate agriculture. This practice leads to an increased exposition of the land surface to rainfall and consequently to increased soil erosion. The productive upper soil layer is removed over time and agricultural productivity decreases. Landslides and gorges reduce the area of agricultural land and can damage roads and buildings. The hydrological regimes of rivers change, the number of rapid floods and potential mud flows increases. Increased sediment load in rivers causes silting of river beds, reservoirs and irrigation system (Asian Development Bank, 2016).

The swollen rivers carry all kinds of materials, e.g.: mud, tree trunks, branches, rubbish, large fraction of sediment, which often stop on the bridge piers and holding the flow. This problem becomes particularly important in extreme conditions, in countries with warmer and humid climates, in the aspect of congested floods or tsunami waves, following earthquakes. The frequency of floods is long-standing and has increased in the last decade, especially in Jakarta, where the numerous threats of rapid and poorly controlled urbanization, combined with the severe degradation of the watershed, have significantly increased runoff. The combination of unsuitable retention basins, an undersized drainage network, increase in non-absorbent areas and soil subsidence created conditions for long-term and extensive flooding during heavy rainfall (Asian Development Bank, 2016).

The Indonesian approach to designing bridge supports has many features in common with the European perspective, including criteria that Polish researchers have distinguished. However, as already described, climatic and weather conditions, seismic activity, but

also mountainous terrain, different from the Polish terms, are factors that have a large impact on developing projects. It should be remembered that Indonesia relies heavily on exports of goods, including via bridges, so bridge failure is usually related to economic loss and functionality (Wahyono, Tangkilisan & Marihandono, 2016; Sumargo & Rusmanto, 2020). The factors influencing the design of the bridge pillar can therefore be divided as follows: stability, location, seismic load, stream pressure, local scouring forecasting, aesthetic, collision risk.

Stability. As part of the substructure portion, the main function of piers is to sustain vertical load and horizontal force from the superstructure (Supriyadi, Siswosukarto & Hadjoh, 2017; Kusuma, Mohammad, Habibi, Yasin & Johan, 2020). Thus, pier stability has a profound effect on influencing slenderness limits at ultimate and serviceability limit states (ULS and SLS) including construction phases, as well. For stability, slenderness defined by Reis and Pedro (2019) could be derived as follows:

$$\lambda = \frac{l_e}{i}$$

where:

l_e – buckling length,

i – relevant radius of gyration of the pier cross-section.

The radius gyration could be calculated as:

$$i = \sqrt{\frac{I}{A}}$$

where:

I – moment of inertia,

A – cross-sectional area.

A smaller λ value indicates a more stable pier shaft, able to resist external loads.

Location. The poor location of the bridge makes it vulnerable to damage and many other problems. Therefore, the location of the bridge is just as important as its characteristics. Choosing a good bridge location involves several factors, such as environmental and geological considerations, hydrology and hydraulics, pre-engineering and road layout. The distance between the pillars must be sufficient to prevent vortexes between them. In the case of rather narrow riverbed there is usually limited space, therefore hammered head type of pier should be used. Nonetheless, for a pier constructed across a wide waterway, solid wall piers become more feasible for dealing with water hydraulic pressure (Fig. 11; Wang, 2000).

Basing on American, Polish and Indonesian literature study it could be noticed that principles, concerning bridge itself and bridge pier could be recognized as rather universal rules and may be specified as following:

- The bridge should be centrally positioned on the main channel of the total floodplain. This could mean an eccentricity of the location in relation to the entire cross-section of the river, but this solution allows more efficient accommodation of normal low flows of the river.
- The waterway opening of the bridge shall be designed so as to provide a sufficiently large flow to

maintain the through-bridge velocity for the designed discharge no higher than the permissible through-bridge velocity.

- The bents should be oriented to conform to the streamlines at flood stage. Standard skew values of 15° , 30° , and 45° should be used if feasible.
- Existing vegetation should be included in the overall bridge plan. Where possible, trees and shrubs should remain intact even within the right-hand side of the road. Vegetation that remains intact also tends to control the turbulent flow (2000 Regulation of Minister of Maritime Economy and Inland Navigation; Texas Department of Transportation, 2004; Subedi, Sharma, Islam & Lamichhane, 2019).

Seismic load. The Indonesian archipelago is geographically situated on the border of three main tectonic plates, the Indo-Australian, Pacific and Eurasian, spreading from Sumatra in the west to Papua in the East. Indonesia is at the point of collision of these three tectonic plates. The high seismic subductivity in this region implies that the tsunami and other earthquake hazards are high as well. The number of earthquakes that have occurred in the region exceeds 48,000, and their scale is greater than 4.0 (from light to great) (Putra, Kiyono, Ono & Parajuli, 2012).

The bridge is subjected to a seismic load induced by an earthquake force that comes from the surface of the Earth. The need to take into account the earthquake phenomenon in Indonesia in model studies due

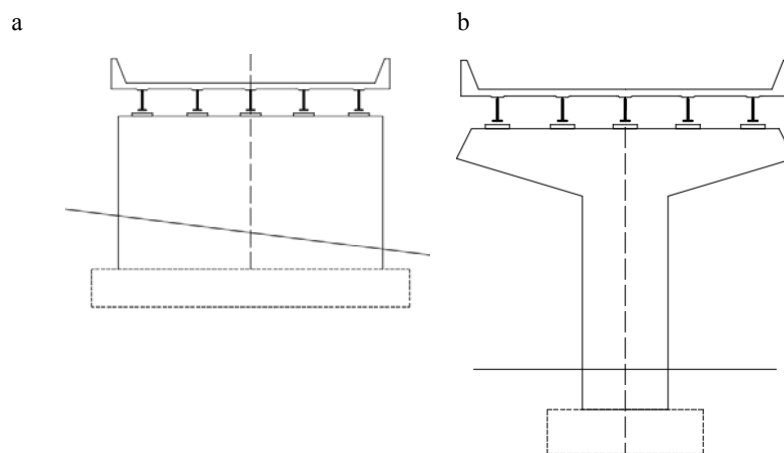

Fig. 11. Piers with various types of cross-sections: a – solid pier, b – hammerhead pier

to the seismic characteristics of the region is underlined (Chen & Duan, 2003; Putra et al., 2012; Guo, Badroddin & Chen, 2018). Earthquakes are also often the cause of landslides, both underwater and those that are initiated on land and enter the riverbed. Therefore, the design of a bridge substructure, in particular, a pier, which has direct contact with the foundation, became more significant in order to have a bridge more resistant against a seismic load (Fig. 12; Tandon, 2005). The construction of the foundation of the bridge pillar takes on particular importance in earthquake conditions. Bridge damage surveys indicate, among other things, damage to the entire bridge structure caused by displacement between driven piles (Hanifah, Budipriyanto & Rahardjo, 2017).

Damage to the bridge by an earthquake can have serious consequences. The collapse of a bridge clearly exposes people at risk and must be replaced after an earthquake, unless substitutive transport routes are identified. Among the minor consequences of destroying the bridge transport disturbances could be listed. In the immediate aftermath of an earthquake, bridge

collapse or closure may impair emergency response operations. Moreover, the economic impact of a bridge closure increases with the time of closure (Chen & Duan, 2003).

Stream pressure. Piers located in a river or strait are subjected to hydrodynamic actions determined by the stream pressure against the pier shape. The pressure can be calculated by using the following formula (Reis & Pedro, 2019):

$$p = \frac{1}{2} c \gamma v^2$$

where:

- c – shape factor of the cross-section of a bridge pier element that directly contacts the water flow,
- γ – unit weight of water (10–12 kN·m⁻³),
- v – water velocity,
- g – gravity acceleration (9.8 m·s⁻²).

The c value of a typical shape of the pier can be seen in Figure 13.

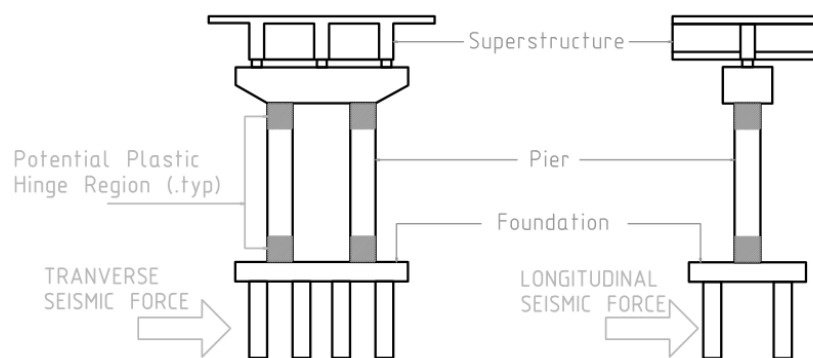

Fig. 12. Seismic force induced by the bridge from the substructure

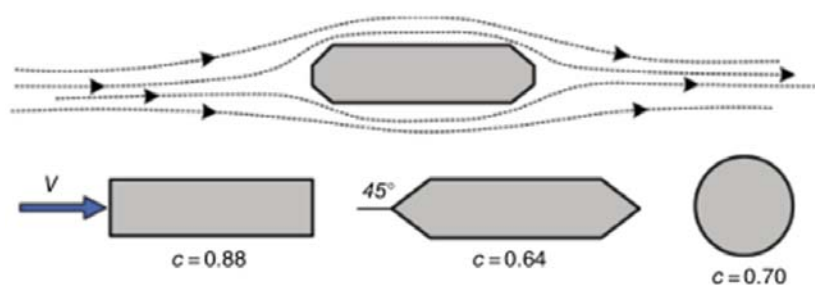

Fig. 13. Typical value of pier shape coefficient

Local scouring forecasting. One of the most often investigated unfavourable phenomena is local scouring in the region of pier (Kusuma et al., 2020). Researchers underline the importance of local scouring research, as a great danger for stability loss, while emphasizing the role of flow rate as a factor determining the size of scour size and shape parameters. The role of the need to calculate the predicted parameters of the local scour hole already at the design stage of the structure is emphasised in order to avoid costly overhauls and reconstructions in the future (Sarminingsih, Soekarno, Hadihardaja & Kusuma, 2014; Amin, Sarino, Haki, 2017; Kusuma et al. 2020). The formation of local scour is particularly acute in the context of the disastrous flood flows that Indonesia is facing especially often (Triatmadja, Hijah & Nurhasanah, 2011; Armono & Budipri-

yanto, 2013; Asian Development Bank, 2016; Wijayanti, Zhu, Hellegers, Budiyo & van Ierland, 2016).

Aesthetic. Bridge design must incorporate the balance of functional requirements and aesthetics. Then, pier shape and configuration play an important role in providing an aesthetic for bridge design. For instance, in a deep valley, the span length to pier height ratio (l_i/h_i) should be maintained constant at each span (Fig. 14). The distance between the pier, therefore, should be reduced as the pier height increase. And for a tall pier, it should have a variation of the cross-section in the lateral direction. Beside the variation of the pier shape cross-section, taller piers often require a hollow section to reduce weight since it will reduce cost demand on the foundation of the bridge (Fig. 15; Wang, 2000).

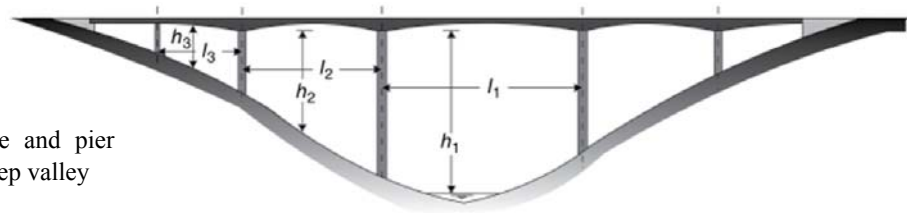

Fig. 14. Ratio of span distance and pier height of bridge in a deep valley

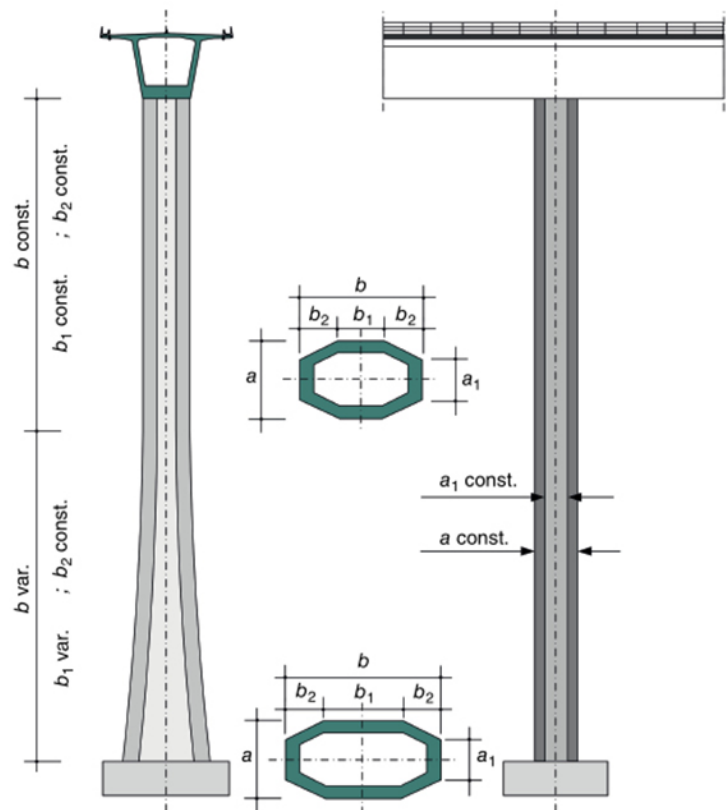

Fig. 15. Variation of cross-section in a tall pier design

Collision risk. Bridge pier design, whether in waterway or on land, should concern collision risk. Especially in a waterway, the collision risk model is already expressed in five components: vessel traffic distribution (N), probability of aberrancy (PA), geometric probability (PG), probability of collapse (PC) and protection factor (PF). As shown in Figure 16, the width of the pier is accumulated is the geometric probability of pier collision.

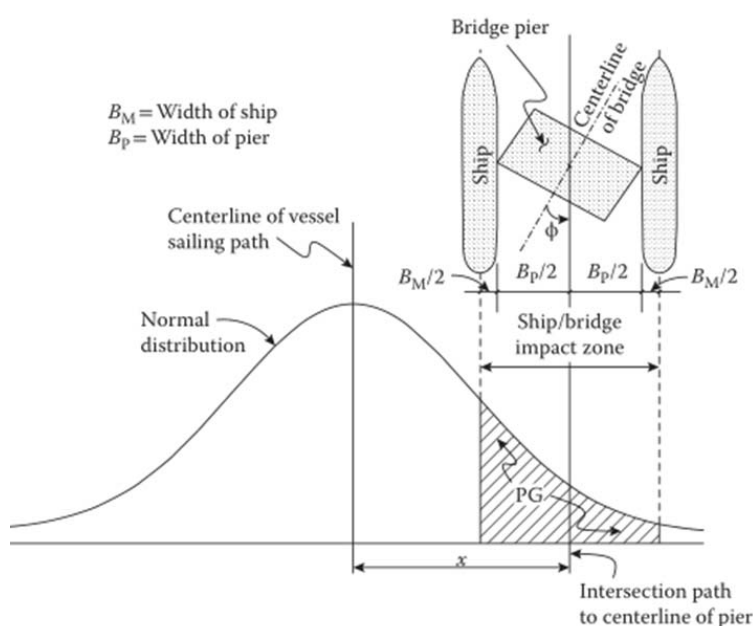

Fig. 16. Collision probability of a bridge pier

Vehicle collision on a pier bridge is evaluated by using damage ratio index (*DRI*) that can be used to define the expected damage due to impact scenarios. The following *DRI* formula has been verified by research (Auyeung, Alipour & Saini, 2019) where V_n is shear resistance:

$$DRI = \frac{\text{kinetic energy}}{\text{pier diameter}} = \frac{\phi V_n}{\text{pier diameter}} \text{ [kJ} \cdot \text{kN}^{-1} \cdot \text{m}^{-1}]$$

The *DRI* formula incorporates only the kinetic energy of the colliding vehicle and the design of the pier without required extensive finite element analysis. The study shows that the pier diameter determines the ability of the pier to resist the impact of a vehicle collision (Auyeung et al., 2019).

REVIEW OF INDONESIAN BRIDGE CONSTRUCTIONS

There is 93,000 bridges in Indonesia with a total length of 1,138 km, of which less than two-thirds of the bridges are a part of urban or local roads and the rest play an important role as part of provincial and national roads (Imran, Hoedajanto & Zarkasi, 2019). Table 1 lists some renowned bridges in Indonesia and Table 2 presents an elevation view of them.

Table 1. The list of main bridges in Indonesia

Name	Location	Main span [m]	Total length [m]	Year built
Ampera Bridge	South Sumatera	75	1 100	1962–1965
LRT Ampera Bridge	South Sumatera	75	1 100	2017
Tukad Bangkung Bridge	Bali	120	360	2006
Siak I Bridge	Kalimantan	52	350	1975–1977
Teuku Fisabilillah	Riau Isles	350	642	1998
Merdeka Bridge	Kalimantan	150	561	2008
Suramadu Bridge	East Java	434	5 438	2009
Bali Strait Bridge	Java-Bali	2 000	2 000	proposal
Sunda Strait Bridge	Java-Sumatera	2 200	2 900	proposal

Table 2. Elevation view of bridges piers

Name, location	Elevation view
Ampera Bridge, South Sumatera	
Tukad Bangkung Bridge, Bali	
Siak I Bridge, Central Kalimantan	
Merdeka/Barito Hulu Bridge, Central Kalimantan	
Suramadu Bridge, East Java	
Sunda Strait Bridge, Java-Sumatera	

Ampera Bridge

The Ampera Bridge (Fig. 17) over the Musi river is an icon of the city of Palembang. It was constructed between 1962 and 1965 at Musi river, with a width of 350 m required to connect the areas of Plaju and Palembang. The leaf type is used in this bridge pier shape to reduce water flow pressure. The Ampera Bridge is located about 90 km from the estuary where

Musi river has about 60,000 km² of catchment area. The average flow of 2,500 m³·s⁻¹ as well as backwater due tide influence in the region of bridge. The most of the maximum flood and sedimentation around that bridge occur during high tide period, invoking local scour phenomenon (Kusuma et al., 2020). Moreover high-performance drainage system is used in the bridge construction.

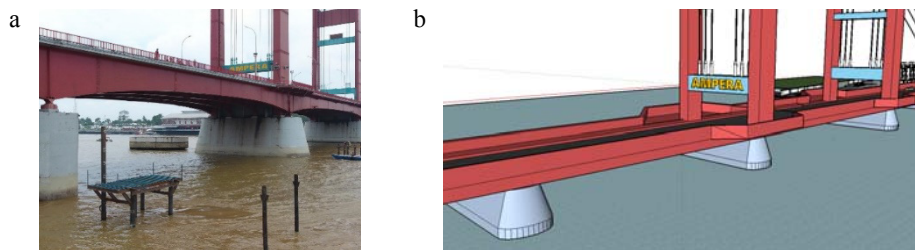

Fig. 17. Ampera Bridge pier: a – real condition, b – 3D modelling

Palembang LRT Bridge

The Palembang Light Rail Transit (Palembang LRT) construction project was started in 2016 with the aim to connect the International Airport and Sport City in Palembang. It is the first LRT system to operate in Indonesia. To preserve the current road capacity, the railroad network and the stations are built at an elevation above ground supported by reinforced concrete piers. After passing Ampera station, the train crosses the Musi river next to the Ampera Bridge. Palembang LRT Bridge runs parallelly to the Ampera Bridge on its own foundations. The reinforced hammerhead piers

are settled on chamfered foundations (Fig. 18). In the context of large bridge structures, the role of proper drainage of buildings, including bridge structures, is emphasised, which has a direct impact on their durability.

Teuku Fisabilillah Bridge

As part of the Bareleng bridges, which consist of six bridges, Tengku Fisabilillah (Fig. 19) is the most popular bridge, which connects Batam and Tonton island with a total span of 642 m and two central piers with a span of 350 m. Teuku Fisabilillah Bridge is a road



Fig. 18. Palembang LRT cross Musi river, Indonesia: a – modelling pier studies, b – plan view of pier foundation; c – LRT bridge after construction

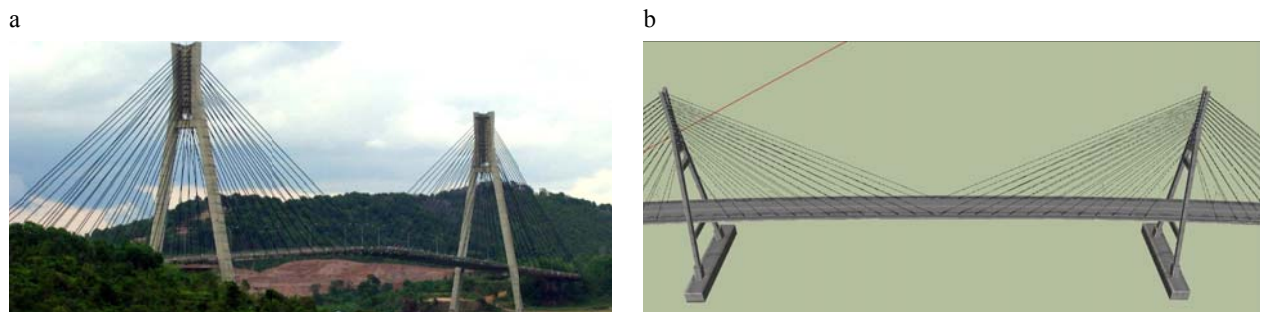

Fig. 19. Fisabilillah Bridge: a – real condition (photo by Soham Banerjee, CC BY 2.0, <https://commons.wikimedia.org/w/index.php?curid=10272265>, b – 3D modelling (designed by R. Suhiman, available at: <https://3dwarehouse.sketchup.com>)

bridge, which piers are made of reinforced concrete and its type is described as cable-stayed bridge with semi-fan system.

Tukad Bakung Bridge

Tukad Bakung Bridge in the village of Plaga, inaugurated its use in 2006. The bridge connects three districts, each of Badung, Bangli, Buleleng, and it became the longest bridge in Bali and claimed to be the highest in Asia. The name of the bridge is taken from Balinese (Indonesia local language) and means Bakung river, since the bridge was built over the river. The bridge was built with balanced cantilever technology with a width of 9.6 m and a total length of 360 m (Abizandhika, Wibisono & Bangun, 2016). From the beginning

till the end of the abutment, Tukad Bakung Bridge has four spans and three piers in between (Fig. 20). According to the people around there have Bakung Tukad Bridge 360 m long, 9.6 m wide, with the highest pier reached 71.14 m, and the foundation more than 12 m below ground. By reason not to reduce the surrounding scenery, the bridge was not built with any pylons or roof on it. Construction of the bridge was expected to withstand earthquakes up to 7 on the Richter scale.

Suramadu Bridge

Located in the East Java Province, Suramadu is the longest Indonesian bridge connecting Surabaya city on Java island and Bangkalan city on Madura island with a total length of 5.4 km (Fig. 21). The V-shape piers

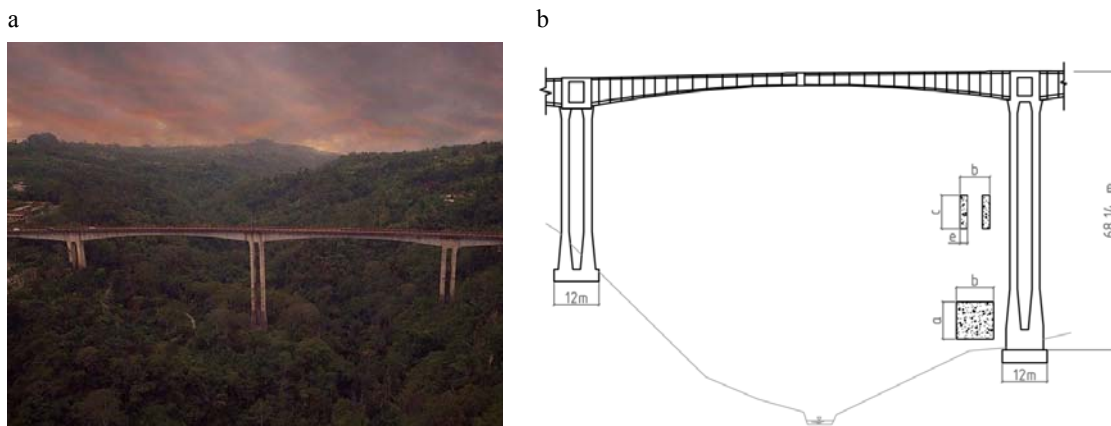

Fig. 20. Tukad Bakung Bridge: a – real condition (<https://www.kintamani.id/wp-content/uploads/Jembatan-Tukad-Bakung-Plaga-3.jpg>), b – cross-section of a tall pier bridge (own elaboration based on Artana, Sukrawa & Sudarsana, 2010)



Fig. 21. 3D modelling of Suramadu Bridge from pier

connect the approach bridges and the main bridge, which is a cable-stayed bridge composed of a steel-concrete composite beam, twin tower pylons and twin cable planes. The creators of the bridge emphasise that the construction of the bridge has had a very positive impact on Surabaya economy, turning them into very attractive areas for investors.

SUMMARY

Bridges are a central component of every nation's transportation system. The paper presents universal principles for the construction of bridge pillars, built in rivers and floodplains. The exemplary shapes of the pillars in the plan and the ways of their foundation are presented as a result of the analysis of English, Polish and Indonesian language literature.

The damage to the bridge is becoming particularly severe for the economy of the archipelago, which is Indonesia. Members of the rural community, who usually live in remote areas, rely heavily on safe routes. In the rainfall period, i.e. during Monsoon, when water level in rivers is piled, bridges are in danger, therefore walks to school, work or health care facilities can become even a threat to life. Without an efficient, reliable and properly maintained transport system, including bridges, the cities or even countries will not be able to maximise its economic potential.

The construction solutions used in tropical climate conditions are determined not only by universal analyses, such as the analysis of dead load of the pier or forecasting local scouring, but also by factors typical for this region. As an example, the considerations of resistance

to earthquakes or frequent floods should be given here. Structural solutions, which in a way respond to adverse climatic conditions, can be summarised as follows:

- Increased frequency of extreme precipitation events has an impact on the risk for flooding, which can reduce the service life of bridges and undermine their stability by increasing the scouring rate in the region of piers and bridge foundations. Floods could also cause an increasing moisture levels in soil, which, subsequently may lead to loss of structural foundation integrity. Also small-scale bridges are more vulnerable since they are often not designed to withstand powerful floods or strong wind. Facing those problems an adaptation could be introduced, amounting to proper pier and foundations protection by strengthening them or using the drainage systems with a higher drainage capacity.
- Water level rise and tsunami surge can cause great damages within the network of bridges and connected roadways due to flooding, inundation, and erosion of land that accommodates infrastructure. Such phenomena could decrease expected lifetime of bridges and result in high magnitude of scouring process by eroding riverbeds and exposing piers and bridge foundations, comprising the threat to their stability. An answer to this problem, besides reinforcing piers and their foundations, is treatment of metal components of the bridge to resist corrosion due to increased exposure to water.

Factors that should be considered in the design of the bridge pier shape, size, and configuration could be variously grouped and presented. From this study, the criteria can be tabulated (Table 3).

Table 3. Some variables that can be taken into account in pier design

Design consideration	Influence on pier design
stability	height of pier, cross-sectional area
location	foundation, size and pier shape
seismic load	ductility of piers
stream pressure	cross-sectional shape of the pier
aesthetic	span length ratio and pier shape configuration
collision risk	pier width, diameter and material

Authors' contributions

Conceptualization: M.K. and A.Y.W.; methodology: M.K. and A.Y.W.; validation: M.K.; formal analysis: M.K. and A.Y.W.; investigation: M.K. and A.Y.W.; resources: M.K. and A.Y.W.; data curation: M.K. and A.Y.W.; writing – original draft preparation: M.K. and A.Y.W.; writing – review and editing: M.K. and A.Y.W.; visualization: M.K. and A.Y.W.; supervision: M.K.; funding acquisition: M.K.

All authors have read and agreed to the published version of the manuscript.

REFERENCES

- Abizandhika, H., Wibisono, H. & Bangun, S. (2016). Perencanaan Ulang Jembatan Tukad Bangkung Kabupaten Badung, Bali Dengan Metode Cable Stayed. *Jurnal Sains dan Teknologi Teknik Utama*, 11 (3), 168–176.
- Ahn, I.-S., Chen, S. S. & O'Connor, J. S. (2006). Accelerated bridge pier construction in the U.S.: seismic implications. In *Structures Congress 2006*. American Society of Civil Engineers. doi: 10.1061/40889(201)79
- Al-Rousan, R. (2020). Behavior of prefabricated full-depth precast concrete bridge deck panel system: optimum prestress level. *Procedia Manufacturing*, 44, 607–614. doi: 10.1016/j.promfg.2020.02.249
- Amin, M. B. A., Sarino, S. & Haki, H. (2017). Floodplain Simulation for Musi River using Integrated 1D/2D Hydrodynamic Model. *MATEC Web of Conferences*, 101, 05023. doi: 10.1051/mateconf/201710105023
- Andrić, J. M. & Lu, D.-G. (2016). Risk assessment of bridges under multiple hazards in operation period. *Safety Science*, 83, 80–92. doi: 10.1016/j.ssci.2015.11.001
- Armono, H. D. & Budipriyanto, A. (2013). A Study on Local Scouring at Suramadu Bridge Piers for Structural Integrity Monitoring. In *Proceedings of the 7th International Conference on Asian and Pacific Coasts (APAC 2013)*, Indonesia, 24–26.09.2013 (pp. 107–112). *Sulawesi Selatan*: Hasanuddin University Press.
- Artana, W., Sukrawa, M. & Sudarsana, K. (2010). *Aspek Perencanaan dan Pelaksanaan Balok Boks Beton Prategang Pada Jembatan Kantilever Seimbang (Kasus Jembatan Tukad Bangkung – Badung – Bali)*. Paper presented at Civil Engineering National Conference 4th (KonTekS 4), Sanur-Bali, 02–03.06.2010.
- Asian Development Bank (2016). *Indonesia Country Water Assessment*. Retrieved from: <https://www.adb.org/sites/default/files/institutional-document/183339/ino-water-assessment.pdf> (accessed 08.12.2019).
- Auyeung, S., Alipour, A., & Saini, D. (2019). Performance-based design of bridge piers under vehicle collision. *Engineering Structures*, 191, 752–765.
- Biliszczuk, J. & Onysyk, J. (2016). Prefabrykacja w mostownictwie. *Nowoczesne Budownictwo Inżynieryjne*, 6, 66–75.
- Chen, W. F. & Duan, L. (2003). *Bridge Engineering. Seismic Design*. Boca Raton: CRC Press.
- Chmielewski, R. (2015). Analiza warunków posadowienia podpór mostów składanych [Analysis of conditions for the foundation of folding bridges pillars]. *Modern Engineering*, 1, 12–21.
- Dąbkowski, L., Skibiński, J. & Żbikowski, A. (1982). *Hydrauliczne podstawy projektów wodnomelioracyjnych*. Warszawa: Państwowe Wydawnictwo Rolnicze i Leśne.
- Eitiveni, I. & Sensuse, D. (2012). Implementation of Tile Based Geographic Information System in Indonesia E-Government. *International Journal of Computer Science Issues*, 9, 156–163.
- Esmaceli, T., Dehghani, A. A., Zahiri, A. R. & Suzuki, K. (2009). 3D Numerical simulation of scouring around bridge piers (Case Study: Bridge 524 crosses the Tanana River). *World Academy of Science, Engineering and Technology*, 58, 1028–1032. doi: 10.5281/zenodo.1074503
- Graf, W. H. (1998). *Fluvial hydraulics: flow and transport processes in channels of simple geometry*. Chichester: John Wiley & Sons.
- Guo, X., Badroddin, M. & Chen, Z. (2018). Scour-dependent empirical fragility modelling of bridge structures under earthquakes. *Advances in Structural Engineering*, 136943321881543, 1–15. doi: 10.1177/1369433218815433
- Hanifah, Y. N., Budipriyanto, A. & Rahardjo, I. P. (2017). Seismic performance evaluation of a pile-supported pier in Aceh, Indonesia. *IOP Conference Series: Materials Science and Engineering*, 012022. doi: 10.1088/1757-899X/267/1/012022
- Hassan, Z. F., Karim, I. R. & Al-Shukur, A. (2020) Effect of Interaction between bridge piers on local scouring in cohesive soils. *Civil Engineering Journal*, 6 (4), 659–669.
- Imran, I. Hoedajanto, D. & Zarkasi, I. (2014). *Bridges in Indonesia: Present and Future. Tokyo-Japan*. Retrieved from: http://jsce100.com/international_conf/pdf/forum09.pdf (accessed 08.12.2019).
- Jarominiak, A. (2011). Postęp w dziedzinie fundamentowania mostów [Advances in bridge foundation]. *Geoinżynieria. Drogi Mosty Tunele*, 1 (30), 14–33.
- Jarominiak, A. (2016). Zabezpieczenie przed rozmyciem dna cieków przy filarach mostów. *Drogownictwo*, 10, 303–312.

- Jukowski, M. & Bęc, J. (2016). Analiza statyczna i modalna Mostu Solidarności w Płocku [Static and modal analysis of Solidarity Bridge in Płock]. *Budownictwo i Architektura*, 15, 177–189.
- Junaidi, A., Nurhamidah, N. & Daoed, D. (2018). Future flood management strategies in Indonesia. *MATEC Web of Conferences*, 229, 01014. doi: 10.1051/matec-conf/201822901014
- Krężel, M. & Radziecki, A. (2007). Próba nowego spojrzenia na zastosowanie prefabrykacji w budownictwie mostowym. *Drogownictwo*, 2, 122–124.
- Kusuma, M. S. B., Mohammad, F., Habibi, S. A., Yasin, D. M. & Johan, E. (2020). The influence of the new LRT pier to the sedimentation pattern around Ampera bridge in Musi river, South Sumatera, Indonesia. *International Journal of GEOMATE*, 18 (69), 159–167. doi: 10.21660/2020.69.13240
- Lewandowski, J. B. (1959). Uwagi na temat głębokości wyboju przy filarze. *Archiwum Hydrotechniki*, 3, 273–287.
- Lin, W. & Yoda, T. (2017). *Bridge Engineering: Classifications, Design Loading, and Analysis Methods*. Oxford: Butterworth–Heinemann.
- Markogiannaki, O. & Tegos, I. (2018). *A proposal for improving regularity of bridges with the rocking response of precast piers*. Paper presented at 16th European Conference On Earthquake Engineering, 18–21.06.2018, Thessaloniki, Greece.
- Matsagar, V., Eslamian, S., Ostad-Ali-Askari, K., Raeisi, M., Lee, G., Pazdar, S. & Bagheri-Basmenji, A. (2018). Bridges. In P.T. Bobrovsky & B. Marker (Eds.), *Encyclopedia of Engineering Geology* (pp. 74–92). Cham: Springer. doi: 10.1007/978-3-319-12127-7_35-1
- Pawitan, H. & Haryani, G. S. (2011). Water resources, sustainability and societal livelihoods in Indonesia. *Ecology & Hydrobiology*, 11 (3–4), 231–243. doi: 10.2478/v10104-011-0050-3
- Putra, R. R., Kiyono, J., Ono, Y. & Parajuli, H. R. (2012). Seismic Hazard Analysis For Indonesia. *Journal of Natural Disaster Science*, 33 (2), 59–70. doi: 10.2328/jnds.33.59
- Reis, A. J. & Pedro, J. J. O. (2019). *Bridge Design: Concepts and Analysis*. Oxford: John Wiley & Sons.
- Rozporządzenie Ministra Transportu i Gospodarki Morskiej z dnia 30 maja 2000 r. w sprawie warunków technicznych, jakim powinny odpowiadać drogowe obiekty inżynierskie i ich usytuowanie. Dz.U. 2000 nr 63, poz. 735 [Regulation of Minister of Maritime Economy and Inland Navigation on the technical conditions to be met by road engineering structures and their location. Journal of Laws of the Republic of Poland 2000 No 63, item 735].
- Sarminingsih, A., Soekarno, I., Hadihardaja, I. K. & Kusuma, M. S. B. (2014). Flood vulnerability assessment of upper Citarum river basin, West Java, Indonesia. *International Journal of Applied Engineering Research*, 9 (23), 22921–22940.
- Subedi, A. S., Sharma, S., Islam, A. & Lamichhane, N. (2019). Quantification of the effect of bridge pier encasement on headwater elevation using HEC-RAS. *Hydrology*, 6 (1), 25. doi: 10.3390/hydrology6010025
- Sumargo, S. & Rusmanto, A. (2020). Moveable bridge inspection in Ancam Port North Kalimantan, Indonesia. *IOP Conference Series Materials Science and Engineering*, 830 (2), 022046. doi: 10.1088/1757-899X/830/2/022046
- Supriyadi, B., Siswosukarto, S., & Hadjoh, S. (2017). Stability analysis of variation span and turning angle against width in suspension bridge. In *Proceedings of the Fifth International Conference on Advances in Civil, Structural and Mechanical Engineering – CSM 2017* (pp. 17–21). New York: Institute of Research Engineers and Doctor. doi: 10.15224/978-1-63248-132-0-34
- Taly, N. (1998). *Design of Modern Highway Bridges*. New York: The McGraw-Hill Companies.
- Tandon, M. (2005). Economical design of earthquake-resistant bridges. *ISET Journal of Earthquake Technology*, 42 (1), 13–20.
- Teli, D., Shrestha, K., Chapagain, S. N. & Pathak, S. (2020). *Final project report on analysis and design of T-girder bridge at Balkumari, Kathmandu-Lalitpur*. Lalitpur: Sagarmatha Engineering College.
- Texas Department of Transportation (2019). *Hydraulic Design Manual*. Texas.
- Triatmadja, R., Hijah, S. N. & Nurhasanah, A. (2011). Scouring Around Coastal Structures Due to Tsunami Surge. In *Proceedings of the 6th Annual International Workshop & Expo on Sumatra Tsunami Disaster & Recovery 2011 in conjunction with 4th South China Sea Tsunami Workshop*, 22–24.11.2011 (pp. 3–18). Tsunami and Disaster Mitigation Research Center (TDMRC).
- Tymiński, T. (2010). Hydrauliczne badania modelowe filarów mostowych na przykładzie wybranych mostów Opola [Hydraulic model research on bridge piers based on the example of selected bridges in Opole]. *Rocznik Ochrona Środowiska*, 12, 879–893.
- Vijayasree, B. A., Eldho, T. I., Mazumder, B. S. & Ahmad, N. (2017). Influence of bridge pier shape on flow field and scour geometry. *International Journal of River Basin Management*, 17 (1), 1–21. doi: 10.1080/15715124.2017.1394315

- Wahyono, E., Tangkilisan, Y. B. & Marihandono, D. (2016). Development of inter-island shipping as a Bridge to Indonesian Archipelago. *Journal of Maritime Research*, 13 (3), 29–38.
- Wang, J. (2000). Piers and Columns. In W.H. Chen & L. Duan (Eds.), *Bridge Engineering Handbook* (pp. 27–1–27–24). Boca Raton: CRC Press.
- Wang, W., Zhou, K., Jing, H., Zuo, J., Li, P., & Li, Z. (2019). Effects of Bridge Piers on Flood Hazards: A Case Study on the Jialing River in China. *Water*, 11 (6), 1181. doi: 10.3390/w11061181
- Watts, F. & Podolny, W. (1976). *Ice loads on bridge piers*. Illinois: Federal Highway Administration.
- Wei, Z., Dalrymple, R. A., Héroult, A., Bilotta, G., Rustico, E. & Yeh, H. (2015). SPH modeling of dynamic impact of tsunami bore on bridge piers. *Coastal Engineering*, 104, 26–42. doi: 10.1016/j.coastaleng.2015.06.008
- Wijayanti, P., Zhu, X., Hellegers, P., Budiyo, Y. & Ierland, E. C. van (2016). Estimation of river flood damages in Jakarta, Indonesia. *Natural Hazards*, 86 (3), 1059–1079. doi: 10.1007/s11069-016-2730-1

PRZEGLĄD ROZWIĄZAŃ KONSTRUKCYJNYCH KSZTAŁTU FILARÓW MOSTOWYCH Z UWZGLĘDNIENIEM PODEJŚCIA INDONEZYJSKIEGO

STRESZCZENIE

Artykuł stanowi przegląd kształtu filarów mostowych, uwzględniając rozwiązania stosowane w Indonezji. Przedstawiono uniwersalne zasady budowy filarów. O rozwiązaniach konstrukcyjnych w warunkach klimatu tropikalnego decydują jednak czynniki regionalne takie jak odporność na trzęsienia ziemi, tsunami czy częste powodzie. W artykule przedstawiono przykładowe kształty filarów w planie oraz sposoby ich posadowienia na podstawie analizy literatury angielskiej, polskiej i indonezyjskiej. Ekonomiczna rola mostu została podkreślona w kontekście archipelagu indonezyjskiego, gdzie stanowi on centralny element systemu transportowego. Uszkodzenia mostu stają się szczególnie dotkliwe dla gospodarki archipelagu indonezyjskiego. Z tego powodu podkreśla się także znaczącą rolę warunków klimatycznych w planowaniu i realizacji obiektów inżynierskich. Rozwiązania konstrukcyjne muszą uwzględniać niekorzystne warunki klimatyczne i polegają głównie na odpowiednim wzmocnieniu w przypadku filarów, systemów odwadniających o większej wydajności oraz na zabezpieczeniu antykorozyjnym elementów metalowych. Czynniki, które należy wziąć pod uwagę przy projektowaniu kształtu, wielkości i konfiguracji filarów mostowych, mogą być różnie pogrupowane i przedstawione. Na podstawie tych badań można wyróżnić następujące kryteria projektowe: stabilność, lokalizacja, obciążenie sejsmiczne, ciśnienie strumienia, estetyka, ryzyko kolizji.

Słowa kluczowe: konstrukcje mostowe, filary mostowe, erozja, lokalne rozmycia, hydrotechnika